

More Precision.



optris® CTfast

Precise noncontact temperature measurement
from -50 to 975°C



FEATURES

- One of the smallest infrared sensors worldwide with extrem short response time down to 6 ms (90 % signal)
- Fast analog output (0/4 - 20 mA, 0 - 5/10 V) with smart real time data processing
- Instant digital 0/10 V output with a response time of 4 ms (50% signal)
- Continuous process monitoring with an unchopped sensor system
Note: Conventional fast pyroelectrical infrared sensors with mechanical chopper see processes only part of the time
- Easy to assemble in multiple arrays for line scanning of small and fast objects (hot spot detection) using a RS485 bus communication
- Rugged up to 120°C ambient temperature without cooling

General specifications	
Environmental rating	IP 65 (NEMA-4)
Ambient temperature	sensing head: -20 - 120°C electronics: 0 - 85°C
Storage temperature	sensing head: -40 - 120°C electronics: -40 - 85°C
Relative humidity	10 - 95%, non condensing
Vibration (sensor)	IEC 68-2-6: 3 G, 11 - 200 Hz, any axis
Shock (sensor)	IEC 68-2-27: 50 G, 11 ms, any axis
Weight	sensing head 40 g electronics 420 g
Electrical specifications	
Analog output	0/4 - 20 mA, 0 - 5/10 V or thermocouple J, K
Alarm output	Open - collector (24V / 50mA)
Digital output	0/10 V (10 mA) optional: relay: 2 x 60 V DC/42 V AC; 0.4 A; optically isolated
Digital interface (optional)	USB, RS232 or RS485, CAN, Profibus DP, Ethernet
Output impedances	mA max. 500 Ω (with 8 - 36 V DC) mV min. 100 kΩ load impedance thermocouple 20 Ω
Inputs	programmable functional inputs for external emissivity adjustment, ambient temperature compensation, trigger (reset of hold functions)
Cable length	1 m (standard), 3 m, 8 m, 15 m
Current draw	max. 100 mA
Power supply	8 - 36 V DC

Measurement specifications	
Temperature range (scalable via programming keys or software)	-50°C bis 975°C
Spectral range	8 - 14 μm
Optical resolution (90% energy)	LT15F 15:1 LT25F 25:1
System accuracy (at ambient temperature 23 ±5°C)	±1% oder ±2°C ^{1), 2)}
Repeatability (at ambient temperature 23 ±5°C)	±0.75% oder ±0.75°C ^{1), 2)}
Temperature resolution (NETD)	LT15F 0.2 K ^{2), 3)} LT25F 0.4 K ^{2), 3)}
Response time ⁴⁾	analog output (90%): LT15F 9 ms LT25F 6 ms digital output (50%): LT15F 4 ms LT25F 3 ms
Emissivity/Gain (adjustable via programming keys or software)	0.100 - 1.100
Transmissivity/Gain (adjustable via programming keys or software)	0.100 - 1.100
Signal processing (parameter adjustable via programming keys or software, respectively)	peak hold, valley hold, average; extended hold function with threshold and hysteresis

¹⁾ whichever is greater with dynamic noise compression

²⁾ at object temperatures $\geq 20^\circ\text{C}$

³⁾ at time constant 100 ms with smart averaging and $T_{\text{amb}} 25^\circ\text{C}$

⁴⁾ with dynamic adaption at low signal levels

optris® CTfast

Optical specifications

15:1 optics

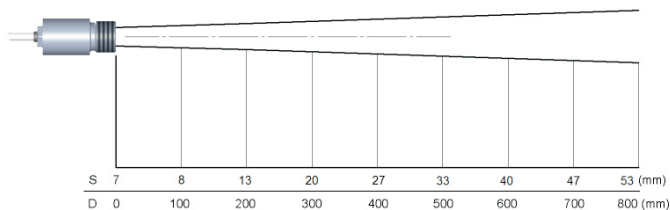

15:1 optics with CF-lens

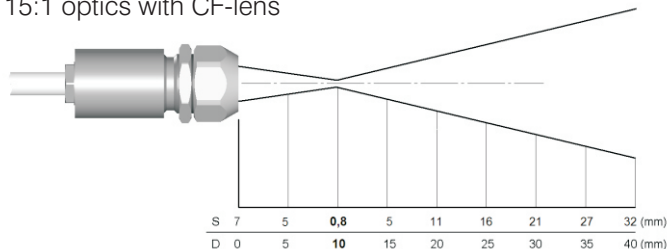

25:1 optics

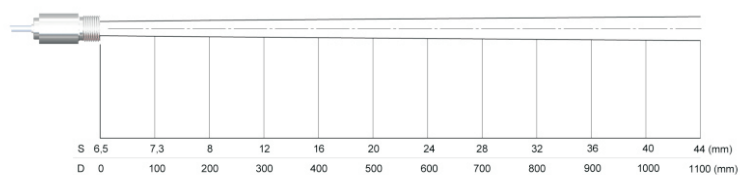

25:1 optics with CF-lens

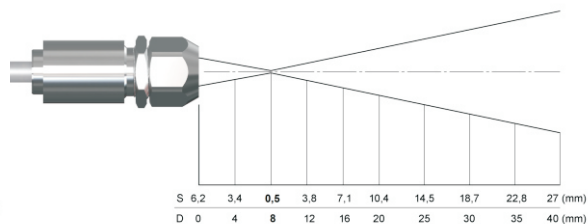

Dimensions

Sensing head

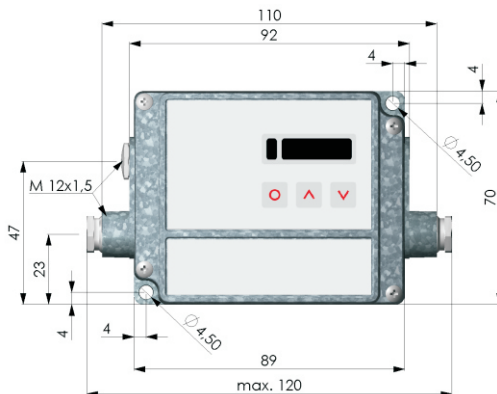
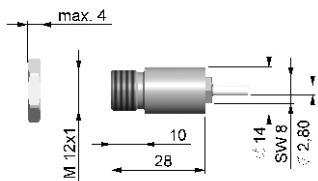

Electronics



Compact Connect Software

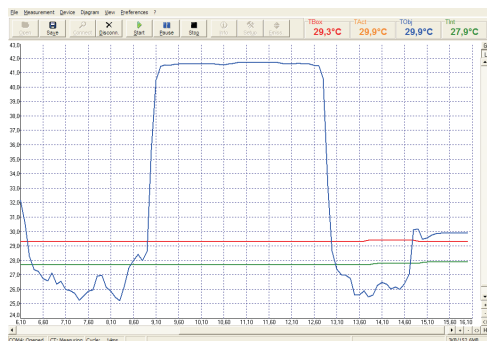

- Software for easy sensor setup and remote controlling, supports multi tasking
- Graphic display for temperature trends and automatic data logging for analysis and documentation with 1 ms response time
- Adjustment of signal processing functions and programming of outputs and functional inputs of the sensor
- Automatic emissivity adjustment
- The software CompactConnect allows to customize the sensor to application needs of the user

Optris GmbH

Ferdinand-Buisson-Str. 14
13127 Berlin

Tel.: +49 (0) 30 500 197-0
Fax: +49 (0) 30 500 197-10

info@optris.de
www.optris.de

Development and sales of portable and stationary infrared measuring instruments.

Specifications are subject to change without notice.
CTfast-DS-E2010-09-C

