

optris® CSmicro 2W LT / LTH

Very small two-wire infrared thermometer for -40°C to 1030°C



FEATURES

- Temperature range: -40°C to 1030°C
- Size: M12x1, 28 mm long, stainless steel housing
- Scalable 4-20 mA analog output / additional simultaneous alarm output
- Rugged coated silicon optics
- Usable up to 180°C ambient temperature without cooling (LTH sensing head)
- Green LED alarm indication, aiming support, self diagnostic or temperature code indication
- Electronics build in cable
- Adjustable signal processing
- Optional USB programming interface and software
- Wide power range: 5-30 V DC

General Specifications

Environmental rating	IP 65 (NEMA-4)
Ambient temperature	-20°C - 120°C (LT sensing head) -20°C - 180°C (LTH sensing head) -20°C - 75°C ¹⁾ (electronics)
Storage temperature	-40°C - 85°C (sensing head and electronics)
Relative humidity	10 - 95%, non condensing
Vibration	IEC 68-2-6: 3 G, 11-200 Hz, any axis
Shock	IEC 68-2-27: 50 G, 11 ms, any axis
Weight	42 g

Electrical Specification

Output/analog	4-20 mA
Loop resistance	max. 1000 Ω ²⁾
Output/alarm	0-30 V/500 mA (open collector)
Output/digital	uni-/bidirectional, 9.6 kBaud, 0/3V digital level, USB (option)
Input	Programmable functional input for triggered signal output or peak-hold function
LED functions	alarm indication, automatic aiming support, self diagnostic, temp. indication (via temp. code)
Cable length	head - electronics: 0.5 m (standard), 3 m, 6 m after electronics: 0.5 m (standard), 3 m
Power supply	5-30 V DC

¹⁾ for V_{cc} (supply voltage) 5-12 VDC / at V_{cc} > 12 VDC the max. ambient temperature of the electronics is 65 °C

²⁾ in dependence on supply voltage

Measurement Specifications

Temperature range (scalable via software)	-40°C - 1030°C
Spectral range	8 - 14 μm
Optical resolution (90 % energy)	15:1
CF-lens (optional)	0.8 mm @ 10 mm
System accuracy	± 1.0% or ± 1.5°C ^{1), 2)}
Repeatability	± 0.75% or ± 0.75°C ^{1), 2)}
Temperature coefficient	± 0.05 K/K oder ± 0.05 % K ³⁾
Temperature resolution	0.1 K ¹⁾
Response time (90%)	30 ms (LT) 150 ms (LTH)
Emissivity/Gain (adjustable via software)	0.100 - 1.100
Transmissivity (adjustable via software)	0.100 - 1.100
Signal processing (parameter adjustable via software)	peak hold, valley hold, average; extended hold function with threshold and hysteresis
Dimensions of electronics	Length: 35 mm Diameter: 12 mm
Software	optris Compact Connect

¹⁾ object temperature > 0°C; whichever is greater

²⁾ at ambient temperature 23 ± 5°C, ε = 1, response time 1s

³⁾ for ambient temperatures <18°C and >28°C; whichever is greater

optris® CSmicro 2W LT / LTH

Optical Specifications

Optics, D:S = 15:1

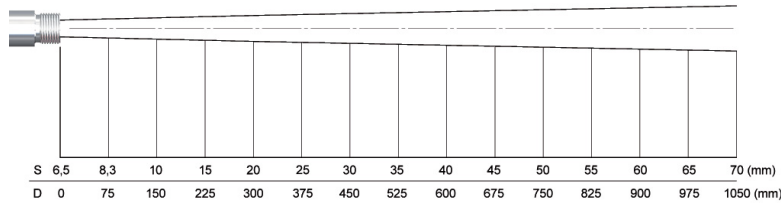

Optics with CF-lens, D:S = 15:1

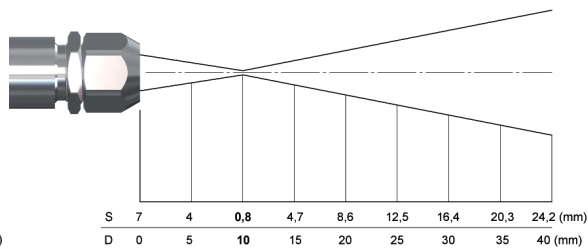

Dimensions/Interfaces

Analog Mode (Two wire connection)

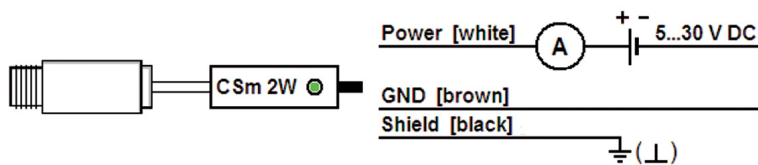

Dimensions optris CSmicro 2W

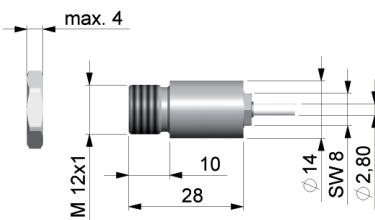

Connection analog with open collector alarm output

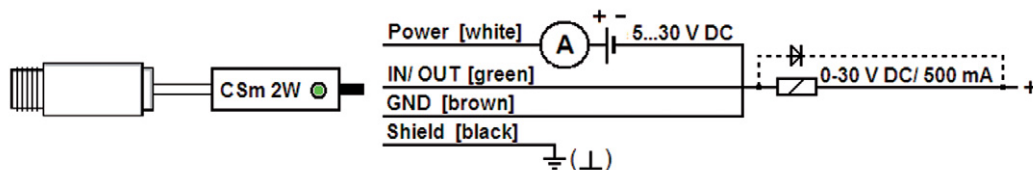

Combined Mode (analog and digital)

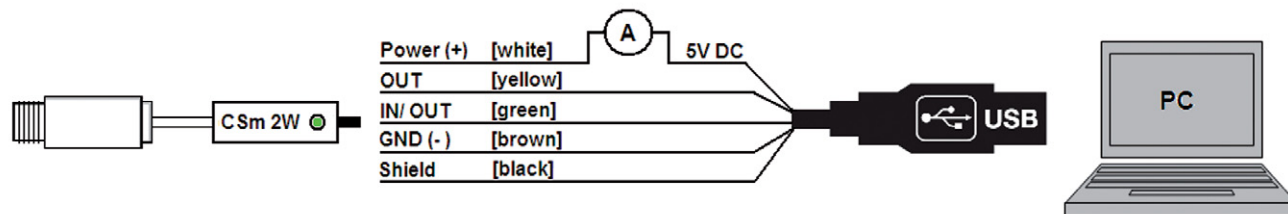

Accessories (examples)

CF-lens (ACCTCF)

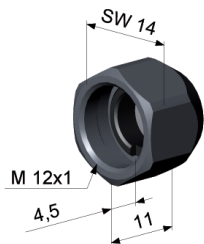

Air purge collar with integrated CF-lens (ACCTAPLCF)

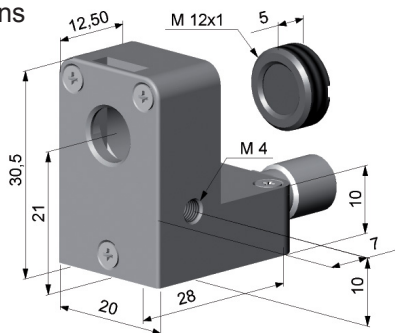

Mounting bracket, fixed (ACCTFB)

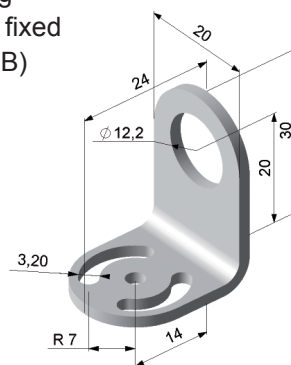

Specifications are subject to change without notice.
CSmicro 2W LT-DS-EZ011-09-A